

Product Overview

The AX-ADPT-MOD is used for measuring air flow, velocity, static and differential pressures of air and non-combustible gases in order to monitor and control building automation, HVAC and cleanroom systems. The measurements can be read and the configuration done via Modbus communication. AX-ADPT-MOD requires less wiring than the traditional 3-wire transmitters because multiple devices can be connected on serial line.



Products Features

- Cost-effective Solution
- Multiple selectable measurement units
- Optional Auto Zero function
- Can be configured to transmit flow measurement

Product Specifications

Power Supply:	24Vac or 24Vdc, ±10%	< 1.3Watts
Output:	Modbus	
Sensor Type:	MEMS, No flow through	
Accuracy:	Model 2K5:	Pressure < 125 Pa = 1 % + ± 2 Pa, Pressure > 125 Pa = 1 % + ± 1 Pa
	Model 7K0:	Pressure < 125Pa = 1.5% + ±2Pa, Pressure > 125Pa = 1.5% + ±1Pa
Overpressure:	Proof:	25kPa
	Burst:	30kPa
Pressure Connection:	Ø5mm and Ø6.3mm ABS connectors	
Electrical Connection:	Screw terminals suitable for cables 0.2-1.5mm ²	
Response Time:	1.0–20 s, selectable via menu or via Modbus register	
Zero Point Calibration:	Automatic autozero, manual pushbutton or via Modbus register	
Compatible Media:	Dry air or non-aggressive gases	
Display :	2-line display (12 characters/line)	
	Line 1: Volume or velocity measurement	
	Line 2: Pressure measurement	
Pressure Units (select via menu):	Pa, kPa, mbar, inWC, mmWC	
Flow Units (select via menu):	Volume:	m ³ /s, m ³ /hr, cfm, l/s
	Velocity:	m/s, ft/min
Protection Standard:	IP54	
Operating Environment:	Temperature:	-20°C to 50°C (Temperature compensated range: 20°C to 50°C)
		-40°C to 50°C (Low temperature model)
		-5°C to 50°C (Models with Auto Zero calibration)
	Humidity:	0 to 95 % RH, non condensing
Country of Origin:	Finland	

Order codes

Part number	Description
AX-ADPT2K5-D-MOD	Air Diff Pressure Transmitter, LCD, -250/+2500 Pa , Modbus
AX-ADPT2K5-AZ-D-MOD	Air Diff Pressure Transmitter, LCD, Auto Zero, -250/+2500 Pa , Modbus
AX-ADPT2K5-LT-D-MOD	Air Diff Pressure Transmitter, LCD, Low Temp, -250/+2500 Pa , Modbus
AX-ADPT7K0-D-MOD	Air Diff Pressure Transmitter, LCD, -250/+7000 Pa , Modbus
AX-ADPT7K0-AZ-D-MOD	Air Diff Pressure Transmitter, LCD, Auto Zero, -250/+7000 Pa , Modbus
AX-ADPT7K0-LT-D-MOD	Air Diff Pressure Transmitter, LCD, Low Temp, -250/+7000 Pa , Modbus

AX-ADPT-MOD

Air Differential Pressure Transmitters - MODBUS



Installation

The unit should be installed by a suitably qualified technician in accordance with prevailing regulations and any guidelines for the equipment to which it is to be connected. This unit is not suitable for use with Mains Voltage. The unit has two fixing lugs moulded into the base for use with screws up to 4mm in diameter. When fixing the transmitter, care should be taken not to stress the unit. The unit is designed to be mounted on a vertical plane with the gland and pressure connections at the bottom of the unit.

Dimensions

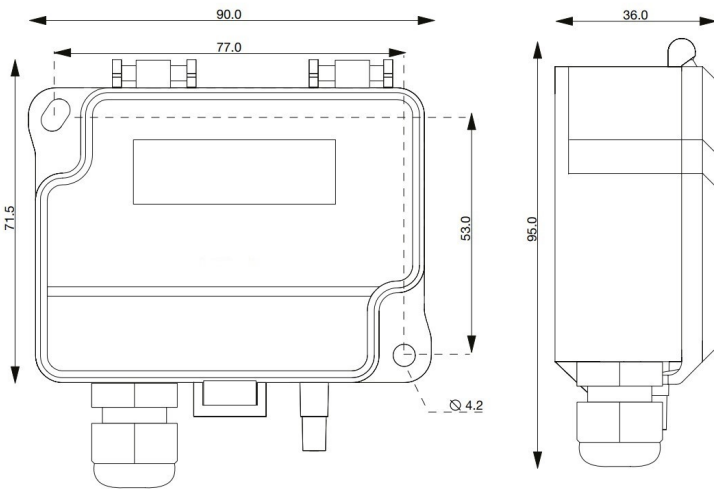

Connections

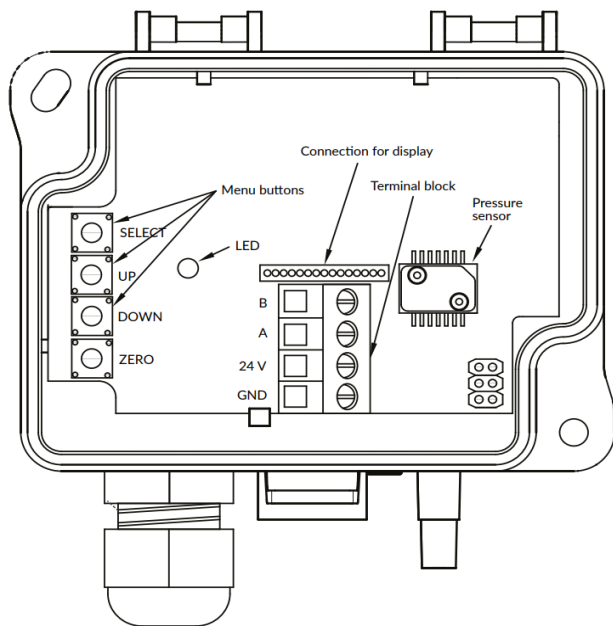

Pressure:

Pressure connections are made by pushing 5-6.3mm PVC tube over the pressure pipes beside the cable gland. Connect the high pressure side to the inlet pipe marked +.

Electrical:

The sensor should be wired as per the appropriate diagram below. The terminal block is a rising clamp type for ease of wiring. Use of shielded cable is highly recommended.

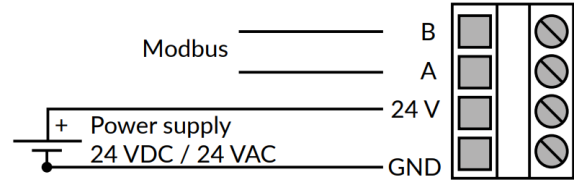

Configuration

The flow unit none is selected by default and the display shows only the pressure reading.

1. Activate the device Menu by pushing the select button for 2 seconds
2. Select the functioning mode of the flow meter:
 - Select Manufacturer when connecting DPT-MOD to a fan with pressure measurement points
 - Select Common probe when using DPT-MOD with a common measurement probe that follows the formula:

$$q = k \cdot \sqrt{\Delta P}$$

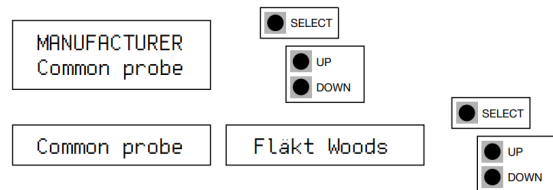

3. If Common probe selected: select measurement units used in the formula (aka Formula unit) (i.e. l/s)

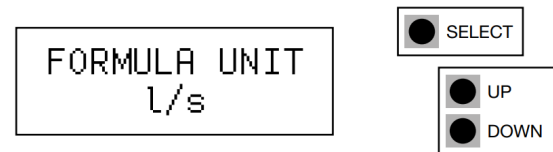

4. Select K-value

- a. If manufacturer selected in step 1:

Each fan has a specific K-value. Select the K-value from fan manufacturer's specifications.

Manufacturer:	K-value:
Flaktwoods	k = 0,3...99
Rosenberg	k = 37...800
Nicotra	k = 10...1500
Comefri	k = 10...2000
Ziehl	k = 10...1500
Ebm-papst	k = 10...1500
Gebhardt	k = 50...4700

Air Differential Pressure Transmitters - MODBUS

b. If Common probe selected in step 1:

Each common probe has a specific K-value. Select the K-value from common probe manufacturer's specifications. Available K-value range: 0.001...9999.000.



5. Select pressure unit for display: Pa, kPa, mbar, inWC, mmWC or none.

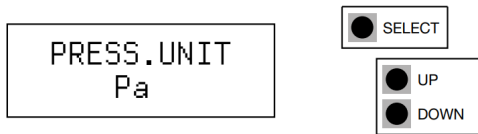

6. Select flow unit for display: Flow volume: m³/s, m³/h, cfm, l/s, none (default) Velocity: m/s, f/min, none

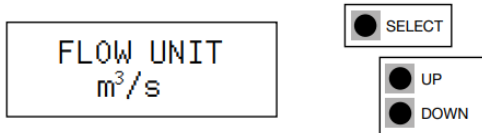

7. Response time: Select response time between 1.0–20 s

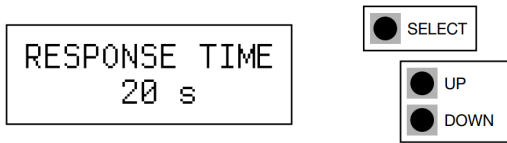

8. Select the address for Modbus: 1...247.

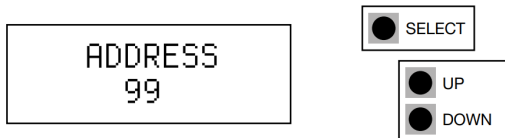

9. Select the baud rate: 9600/19200/38400.

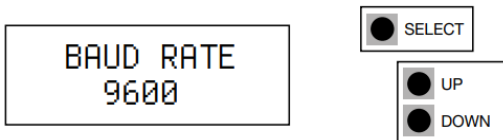

10. Select the parity bit: None/Even/Odd.



11. Push select button to save changes and to exit menu.

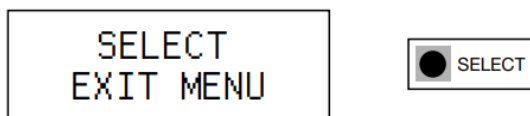

Zeroing the device

Always zero the device before use.

To zero the device three options are available:

1) Manual Pushbutton zero point calibration

Supply voltage must be connected at least one hour prior to zero point adjustment.

Disconnect both pressure tubes from the pressure ports labelled + and –.

Push down the zero button until the LED light (red) turns on and the display reads “zeroing”.

The zeroing of the device will proceed automatically. Zeroing is complete when the LED turns off, and the display reads 0

Reinstall the pressure tubes ensuring that the High pressure tube is connected to the port labelled +, and the Low pressure tube is connected to the port labelled –.

2) Autozero calibration

If the device includes the optional autozero circuit, no action is required.

Autozero calibration (-AZ) is an autozero function in the form of an automatic zeroing circuit built into the PCB board. The autozero calibration electronically adjusts the transmitter zero at predetermined time intervals (every 10 minutes). The function eliminates all output signal drift due to thermal, electronic or mechanical effects, as well as the need for technicians to remove high and low pressure tubes when performing initial or periodic transmitter zero point calibration. The autozero adjustment takes 4 seconds after which the device returns to its normal measuring mode. During the 4 second adjustment period, the output and display values will freeze to the latest measured value. Transmitters equipped with the autozero calibration are virtually maintenance free.

3) Via Modbus register

Make sure there is no pressure in the duct when the zeroing is done via Modbus register.

Low temperature model

The lid of the device has to be closed when the operation temperature is below 0 °C. The display needs 15 minutes to warm up if the device is started in temperature below 0 °C.

Communication

Protocol: MODBUS over Serial Line

Transmission Mode: RTU

Interface: RS485 Byte format (11 bits) in RTU mode:

Coding System: 8-bit binary

Bits per Byte: 1 start bit, 8 data bits (lsb sent first), 1 bit for parity, 1 stop bit

Baud rate: selectable in configuration

Modbus address: 1-247 addresses selectable in configuration menu

Modbus registers

Function code 04 - Read input register

Register	Parameter description	Data Type	Value	Range
3x0001	Program version	16 bit	0...9900	0,00...99,00
3x0002	Pressure reading	16 bit	-250...2500/7000	-250...2500/7000 Pa
3x0003	Flow m3/s	16 bit	0...10000	0...100 m3/s
3x0004	Flow m3/h	16 bit	0...30000	0...30000 m3/h
3x0005	Flow cfm	16 bit	0...30000	0...30000 cfm
3x0006	Flow l/s	16 bit	0...3000	0...3000 l/s
3x0007	Velocity m/s	16 bit	0...1000	0...100 m/s
3x0008	Velocity f/min	16 bit	0...5000	0...5000 f/min

Function code 05 - Write single coil

Register	Parameter description	Data Type	Value	Range
0x0001	Zero point calibration	Bit 0	0...1	On - Off

Function code 03 - Read input holding register

Register	Parameter description	Data Type	Value	Range
4x0001	Manufacturer	16 bit	0...7	0...7
4x0002	Formula unit (Manufacturer=7)	16 bit	0...5	0: m3/s, 1: m3/h, 2: cfm, 3: l/s, 4: m/s, 5: f/min
4x0003	K-factor integer	16 bit	0...9999	0...9999
4x0004	K-factor decimal	16 bit	0...999	0...999
4x0005	Response time	16 bit	1...20	1...20 s

Function code 06 - Write single register

Register	Parameter description	Data Type	Value	Range
4x0001	Manufacturer	16 bit	0...7	0...7
4x0002	Formula unit (Manufacturer=7)	16 bit	0...5	0: m ³ /s, 1: m ³ /h, 2: cfm, 3: l/s, 4: m/s, 5: f/min
4x0003	K-factor integer	16 bit	0...9999	0...9999
4x0004	K-factor decimal	16 bit	0...999	0...999
4x0005	Response time	16 bit	1...20	1...20 s

Function code 16 - Write multiple registers

Register	Parameter description	Data Type	Value	Range
4x0001	Manufacturer	16 bit	0...7	0...7
4x0002	Formula unit (Manufacturer=7)	16 bit	0...5	0: m ³ /s, 1: m ³ /h, 2: cfm, 3: l/s, 4: m/s, 5: f/min
4x0003	K-factor integer	16 bit	0...9999	0...9999
4x0004	K-factor decimal	16 bit	0...999	0...999
4x0005	Response time	16 bit	1...20	1...20 s

Datasheet Contents

Every effort has been taken in the production of this data sheet to ensure accuracy. Annicom do not accept responsibility for any damage, expense, injury, loss or consequential loss resulting from any errors or omissions. Annicom has a policy of continuous improvement and reserves the right to change this specification without notice.